

**Product Parameters:**

- \* Product Name: Led Lens
- \* Part Number : KB-PL11.5-G07-170-2835
- \* Product Size :  $\phi 11.5 * H4.38\text{mm}$
  
- \* Beam Angle : 170 degree
- \* Material : PMMA
- \* PCB hole-drilling: NO
  
- \* Tolerance:  $\pm 0.15\text{mm}$
- \* Work Temperature :  $-40 \sim 90^{\circ}\text{C}$
- \* Transmittance: 93%
  
- \* Application: led panel light (2.5~3cm thickness)  
led advertisement light box
- \* Assembly : Glue/SMT Machine
- \* Match Led : SMD2835|3030 Leds



\* Product Advantages

Lens bottom hole size is big, easy for led SMT processing.  
It can be used in 4mm thickness light box, uniform light spot with high illumination.

**Product Drawing:**

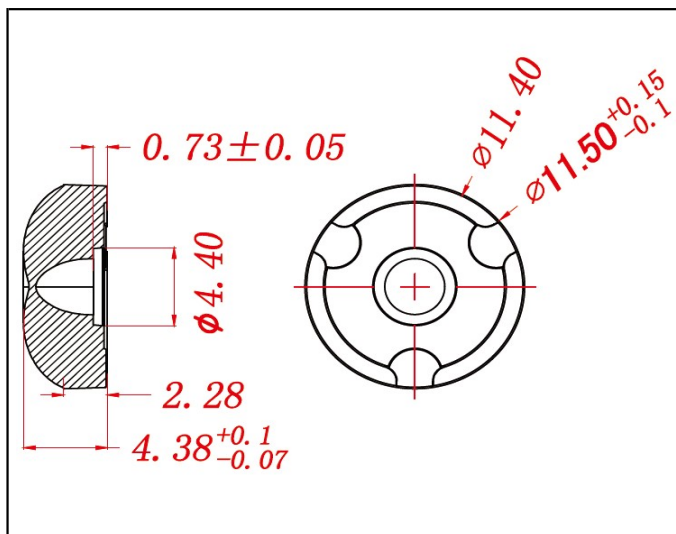

**Light Distribution Curve:**

