

Specification

● Product Parameters:

- ◆ ◆ Product Name: LED High Bay Lens
- ◆ ◆ Part Number: KB-HB24W-30-3030
- ◆ ◆ Dimension: L50*W50*H7.7mm
- ◆ ◆ Beam Angle: 30°
- ◆ ◆ Compatible Led: SMD3030
- ◆ ◆ Material: PMMA/PC
- ◆ ◆ Tolerance: ± 0.1 mm
- ◆ ◆ Working Temperature: PMMA - 40 to 90 °C
PC - 40 to 110 °C
- ◆ ◆ Transmittance: 93%



● Optical Characteristics

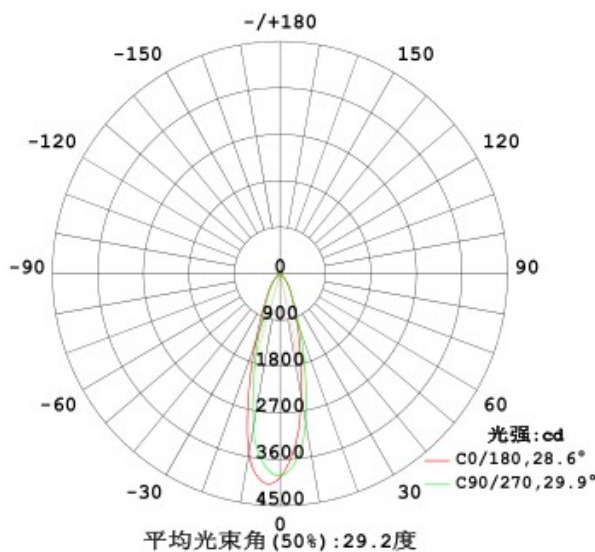

● Mechanical Characteristics:

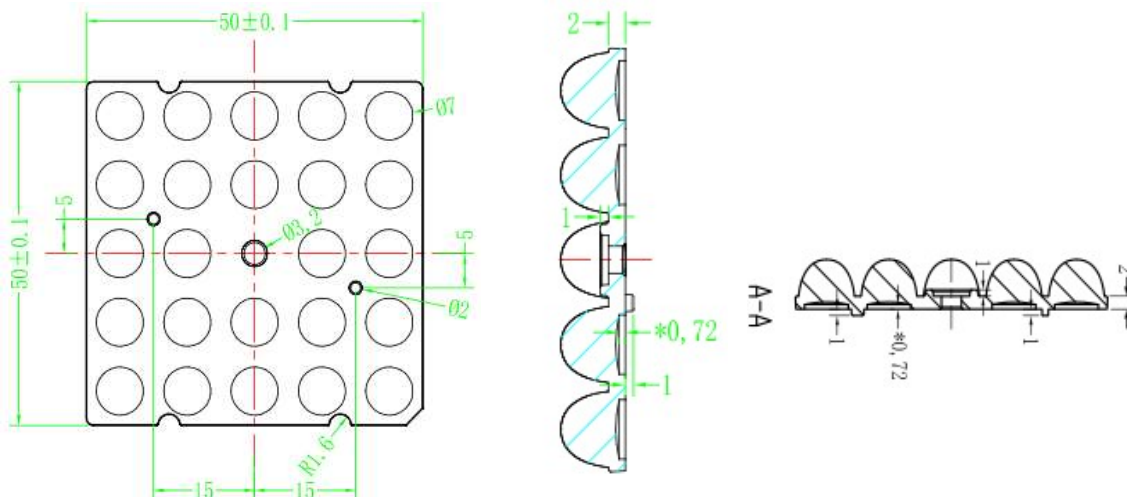

Specification

● Product Parameters:

- ◆ ◆ Product Name: LED High Bay Lens
- ◆ ◆ Part Number: KB-HB24W-60-3030
- ◆ ◆ Dimension: L50*W50*H5.8mm
- ◆ ◆ Beam Angle: 60°
- ◆ ◆ Compatible Led: SMD3030
- ◆ ◆ Material: PMMA/PC
- ◆ ◆ Tolerance: ± 0.1 mm
- ◆ ◆ Working Temperature: PMMA - 40 to 90 °C
PC - 40 to 110 °C
- ◆ ◆ Transmittance: 93%



● Optical Characteristics

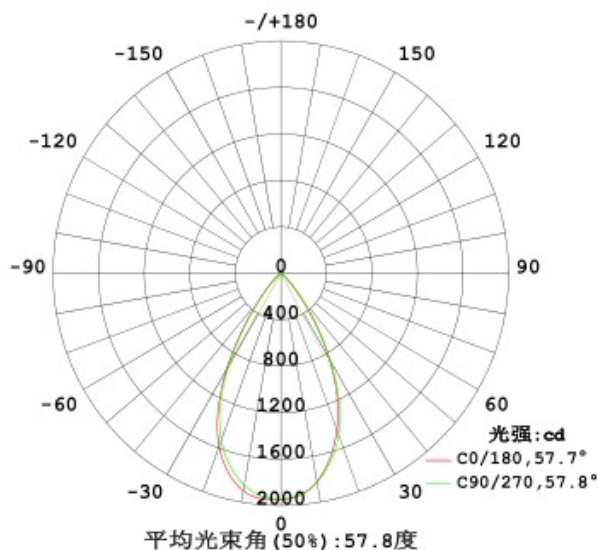

● Mechanical Characteristics:

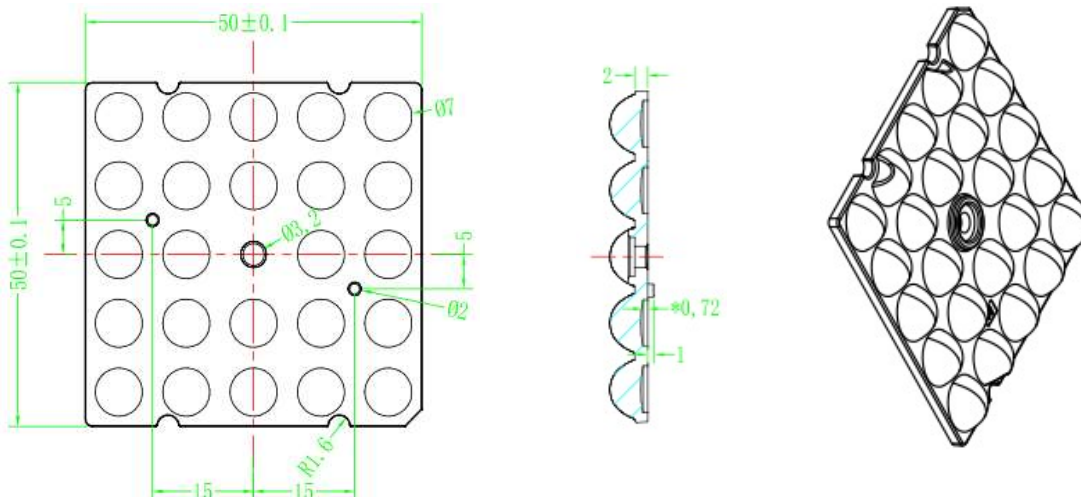

Specification

● Product Parameters:

- ◆ ◆ Product Name: LED High Bay Lens
- ◆ ◆ Part Number: KB-HB24W-90-3030
- ◆ ◆ Dimension: L50*W50*H4.51mm
- ◆ ◆ Beam Angle: 90°
- ◆ ◆ Compatible Led: SMD3030
- ◆ ◆ Material: PMMA/PC
- ◆ ◆ Tolerance: ± 0.1 mm
- ◆ ◆ Working Temperature: PMMA - 40 to 90 °C
PC - 40 to 110 °C
- ◆ ◆ Transmittance: 93%



● Optical Characteristics

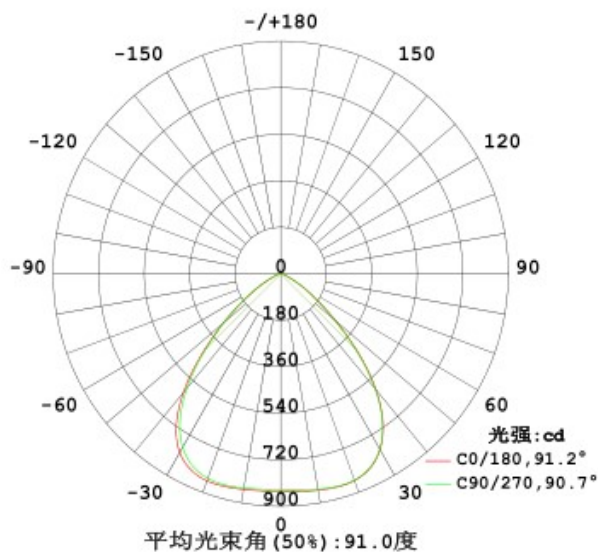

● Mechanical Characteristics:

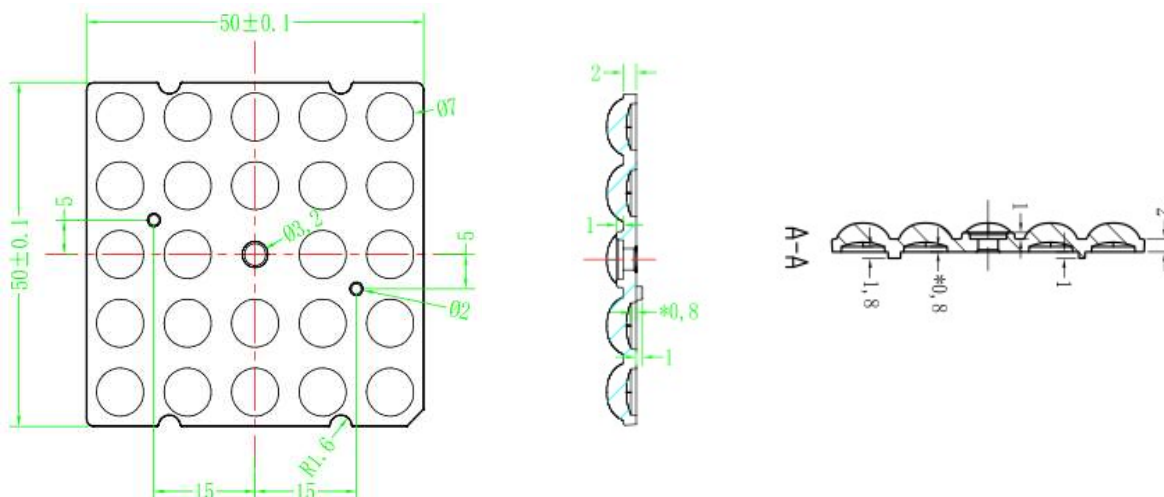

Specification

● Product Parameters:

- ◆ ◆ Product Name: LED High Bay Lens
- ◆ ◆ Part Number: KB-HB24W-120-3030
- ◆ ◆ Dimension: L50*W50*H3.17mm
- ◆ ◆ Beam Angle: 120°
- ◆ ◆ Compatible Led: SMD3030
- ◆ ◆ Material: PMMA/PC
- ◆ ◆ Tolerance: ± 0.1 mm
- ◆ ◆ Working Temperature: PMMA - 40 to 90 °C
PC - 40 to 110 °C
- ◆ ◆ Transmittance: 93%



● Optical Characteristics

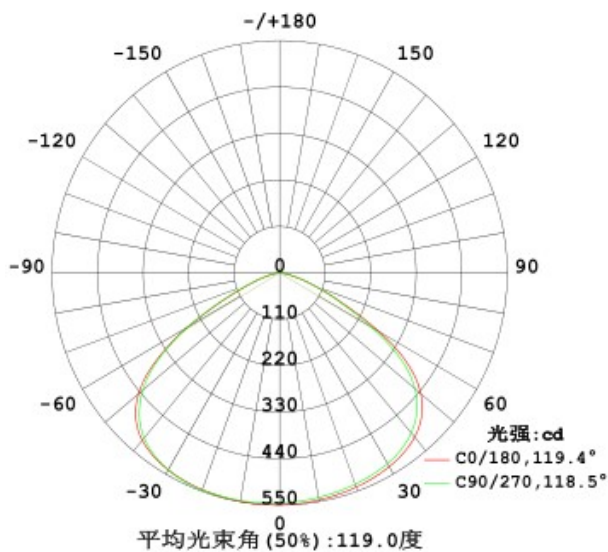

● Mechanical Characteristics:

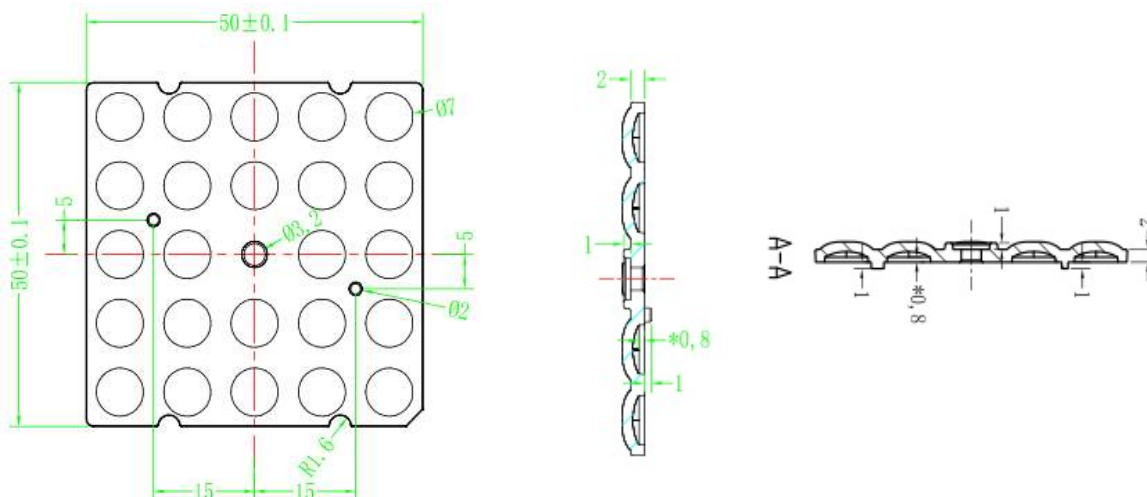

Specification

● Product Parameters:

- ◆ ◆ Product Name: LED StreetLight Lens
- ◆ ◆ Part Number: KB-SL24W-TP2M-3030
- ◆ ◆ Dimension: L50*W50*H4.09mm
- ◆ ◆ Beam Angle: Type II-M
- ◆ ◆ Compatible Led: SMD3030
- ◆ ◆ Material: PMMA/PC
- ◆ ◆ Tolerance: ± 0.1 mm
- ◆ ◆ Working Temperature: PMMA - 40 to 90 °C
PC - 40 to 110 °C
- ◆ ◆ Transmittance: 93%



● Optical Characteristics

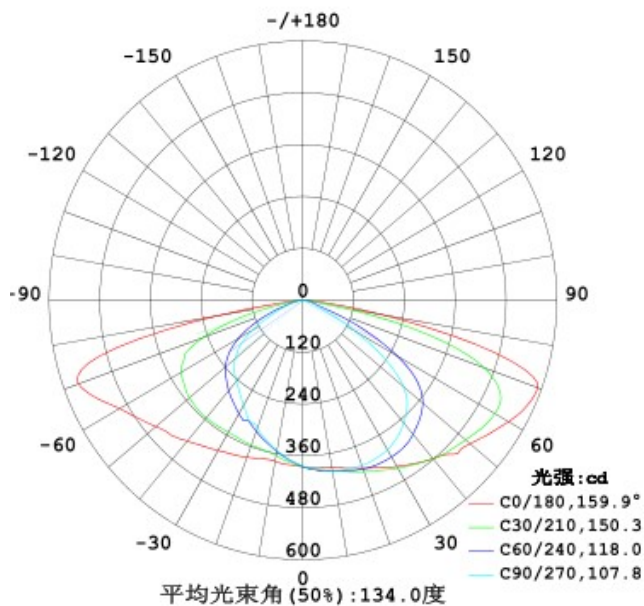

● Mechanical Characteristics:

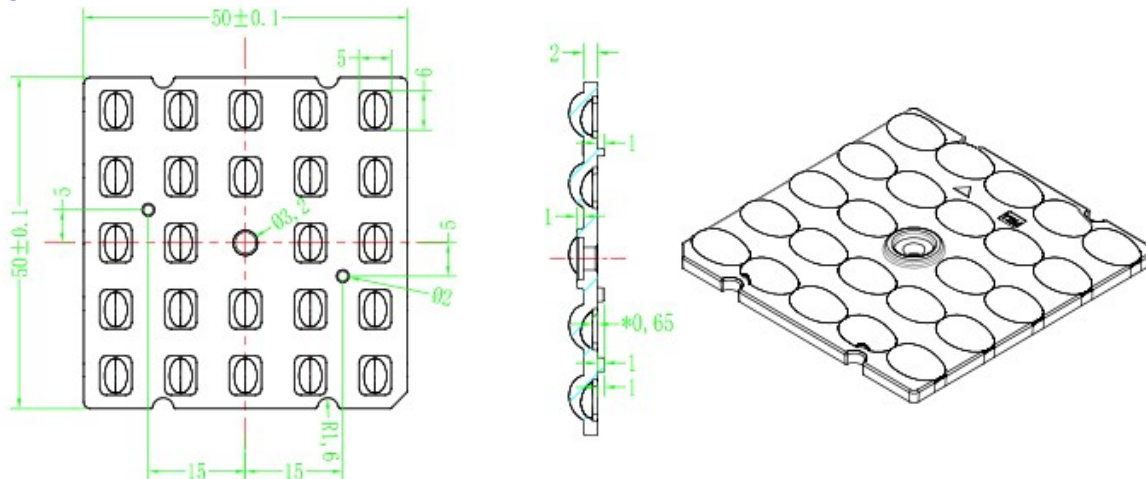

Specification

● Product Parameters:

- ◆ ◆ Product Name: LED StreetLight Lens
- ◆ ◆ Part Number: KB-SL24W-TP3M-3030
- ◆ ◆ Dimension: L50*W50*H4.16mm
- ◆ ◆ Beam Angle: Type III-M
- ◆ ◆ Compatible Led: SMD3030
- ◆ ◆ Material: PMMA/PC
- ◆ ◆ Tolerance: ± 0.1 mm
- ◆ ◆ Working Temperature: PMMA - 40 to 90 °C
PC - 40 to 110 °C
- ◆ ◆ Transmittance: 93%



● Optical Characteristics

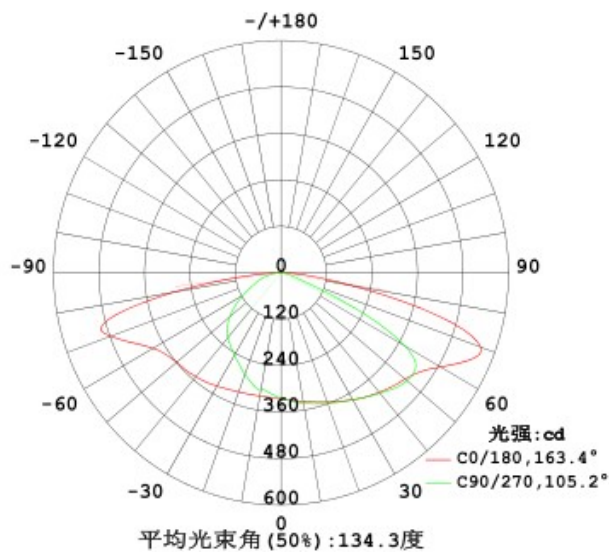

● Mechanical Characteristics:

