

Product Parameters:

- * Product Name: COB Led Reflector
- * Part Number : KB-D9245-24RF-K
KB-D9245-40RF-K
KB-D9245-60RF-K

- * Product Size : $\Phi 92*\Phi 27*H44.3\text{mm}$
- * Beam Angle : 24 degree(half angle)
40 degree(half angle)
60 degree(half angle)



- * Product Inlude : Reflector+Holder+Cover
- * Material : PC with coating
- * Tolerance: $\pm 0.1\text{mm}$
- * Operating Temperature : $-40 \sim 110^{\circ}\text{C}$
- * Lens Light Efficiency : 86~88%
- * Assembly : Frame
- * Match Led : Cree -CXA15xx/18xx/2520
Citizen-CLL020/030/040
Luminus-CXM-14

* Direction for use

- 1, Please use some soft paper or pure water to clean lens (reflector)
- 2, Don't use any industrial solvent to clean lens surface , such as alcohol
- 3, Storage environment : Temperature $0\sim 40^{\circ}\text{C}$, Humidity 30%~95%
- 4, This kind of lens can make the lighting more concentrated, and it's made from transparent material , so please do not open the packages until you use them, in case of the dust and other pollutions.

Product Package:



Optical Characteristics:

Part Number:KB-D9245-24RF-K

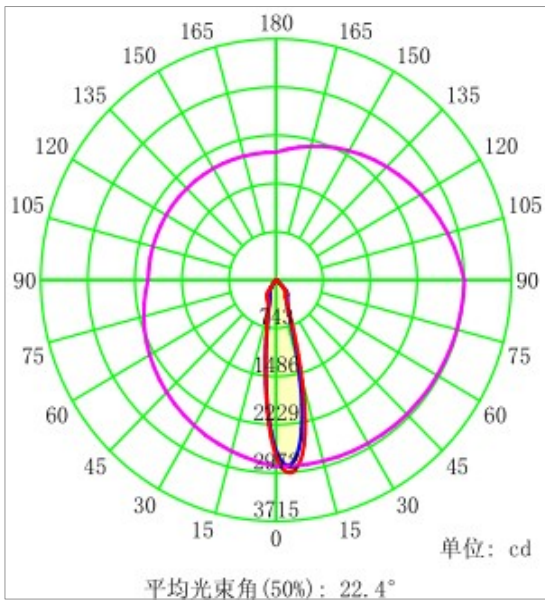

Part Number:KB-D9245-40RF-K

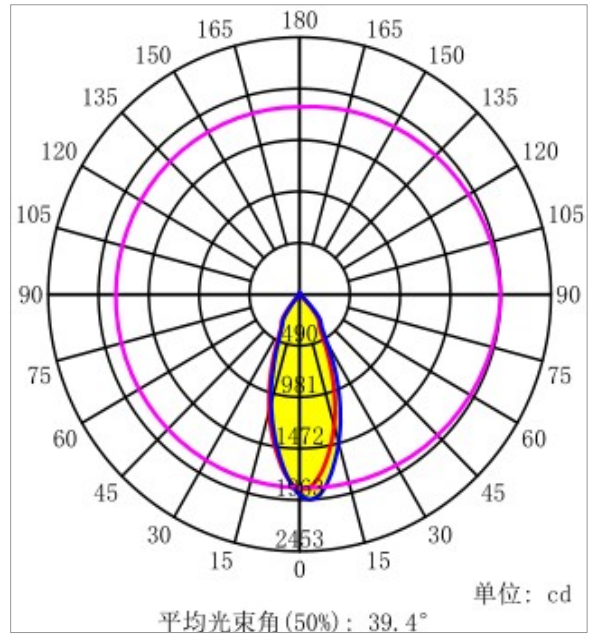

Part Number:KB-D9245-60RF-K

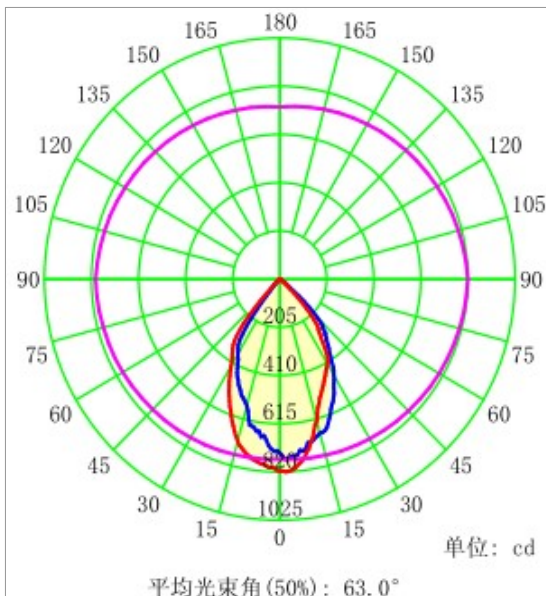

Mechanical Characteristics:

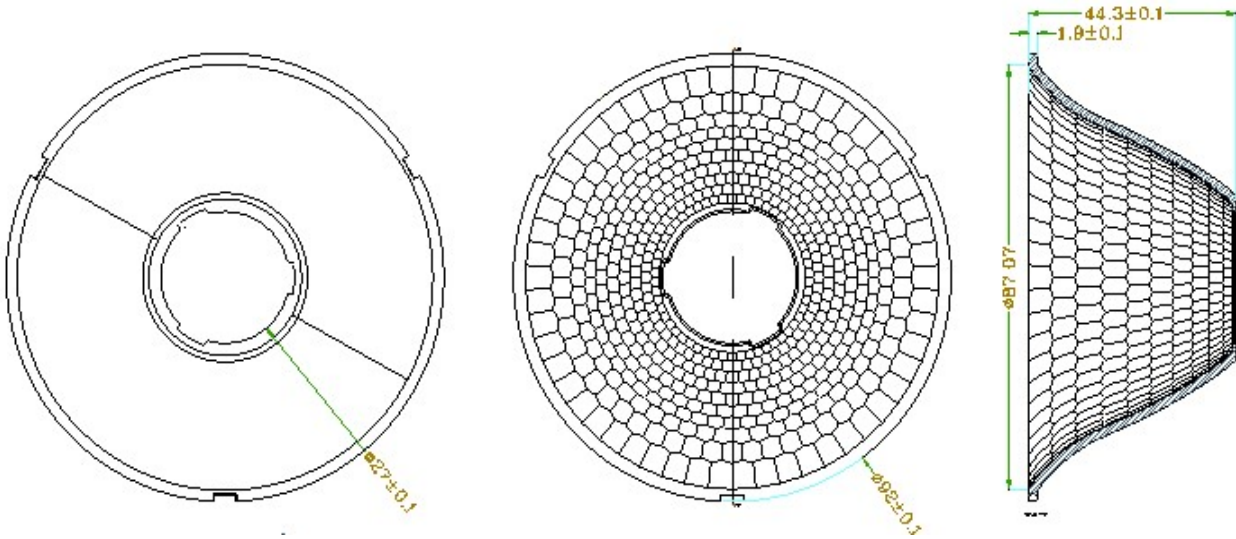

Matched COB Holder

Citizen-CLL030

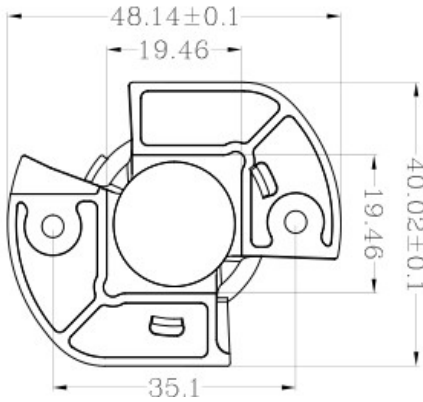

CREE-CXA1507

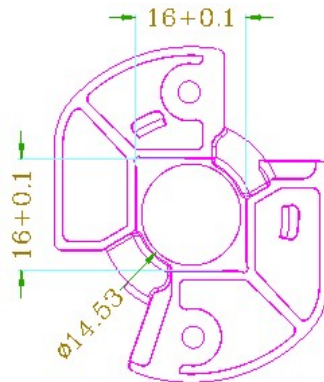

CREE-CXA18xx

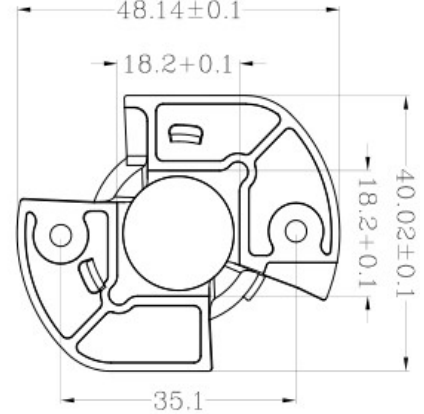

Solderless holder

