

### Product Parameters (产品描述)

产品编号 | Part Number: KB-H20-xx-5050  
出光角度 | Beam Angle: 25/30/15\*30/25\*45°  
产品材料 | Material: Lens-PMMA/Holder-PC  
工作温度 | Work Temp: <85°C

安装方式 | Fastening: Pins/Glue  
支架颜色 | Holder Color: White/Black  
透光率 | Transmittance: 93%  
匹配LED | Match Led: SMD5050/5050RGBW

Part Number	Lens Surface	Dimension	Beam Angle
KB-H20-25P-5050	珠面/beads	Φ22.0*H12.2mm	~25°
KB-H20-30P-5050	珠面/beads	Φ22.0*H12.2mm	~30°
KB-H20-1530-5050	条纹面/ellipse	Φ22.0*H12.2mm	~15*30°
KB-H20-2545-5050	条纹面/ellipse	Φ22.0*H12.2mm	~25*45°

### Direction for Use

#### (透镜 | LENS)

- 1, Please use some soft paper or pure water to clean lens ( reflector)
- 2, Don't use any industrial solvent to clean lens surface , such as alcohol
- 3, Storage environment : Temperature 0~40°C , Humidity 30%~95%
- 4, This kind of lens can make the lighting more concentrated, and it's made from transparent material , so please do not open the packages until you use them, in case of the dust and other pollutions.

#### (双面胶 | TAPE)

- 1, Ensure the assembled pcb is straight, so the tape can be fully stuck to the surface.
- 2, Ensure the assembled pcb is clean and dry, any dirt or unknown chemicals may affect the tape viscous force.
- 3, Stress lens 1~5 seconds after assembly to ensure 100% bond.
- 4, Check lens one by one after assembly to ensure all lens are stucked properly, if lens was not stucked to led perfectly, lens will be a bit suspended, picked it off to stick again or replace with a new tape.

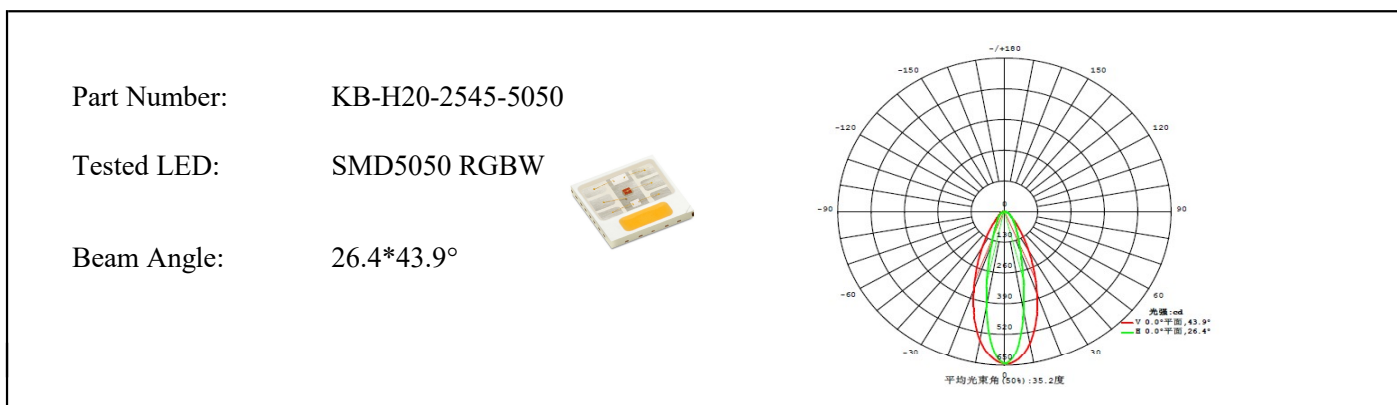
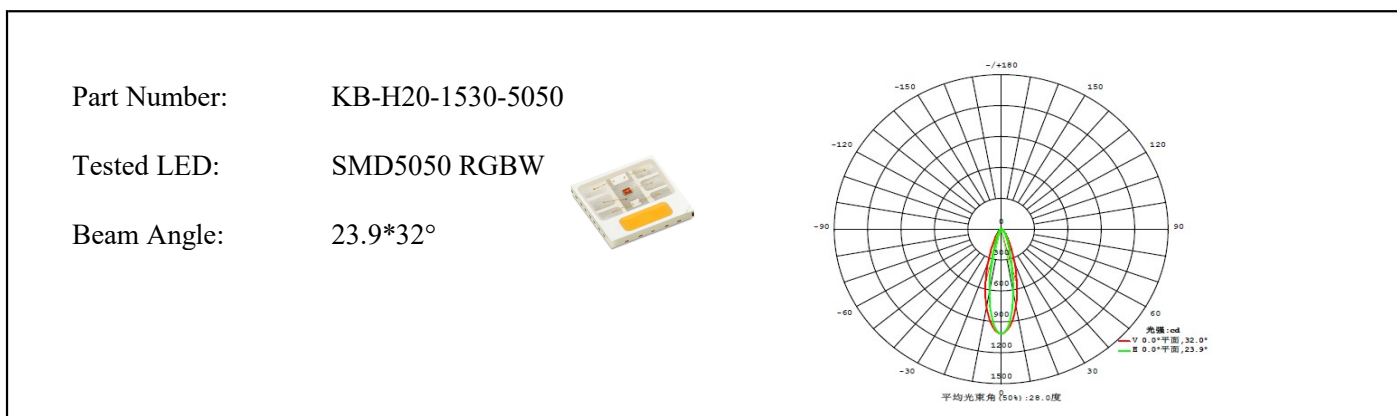
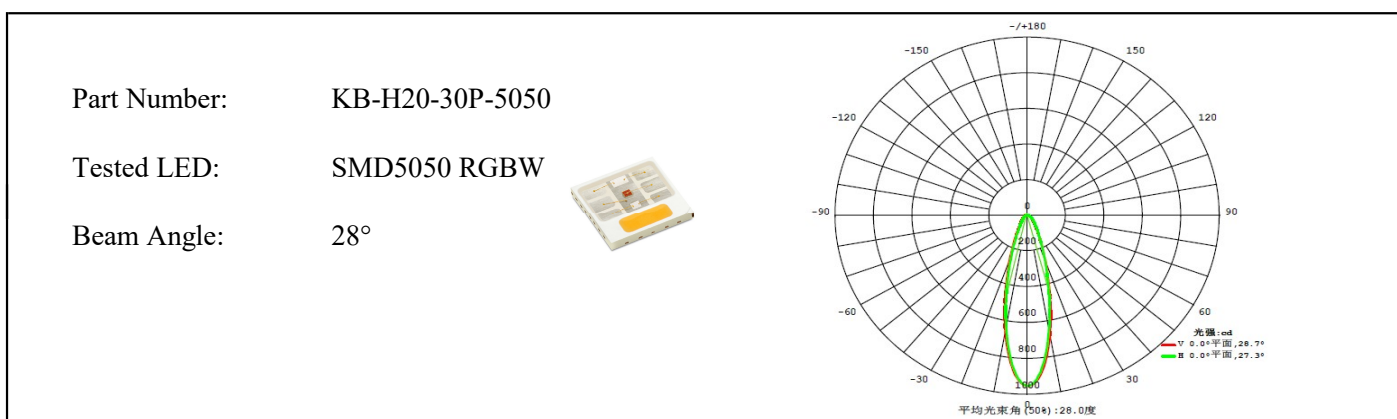
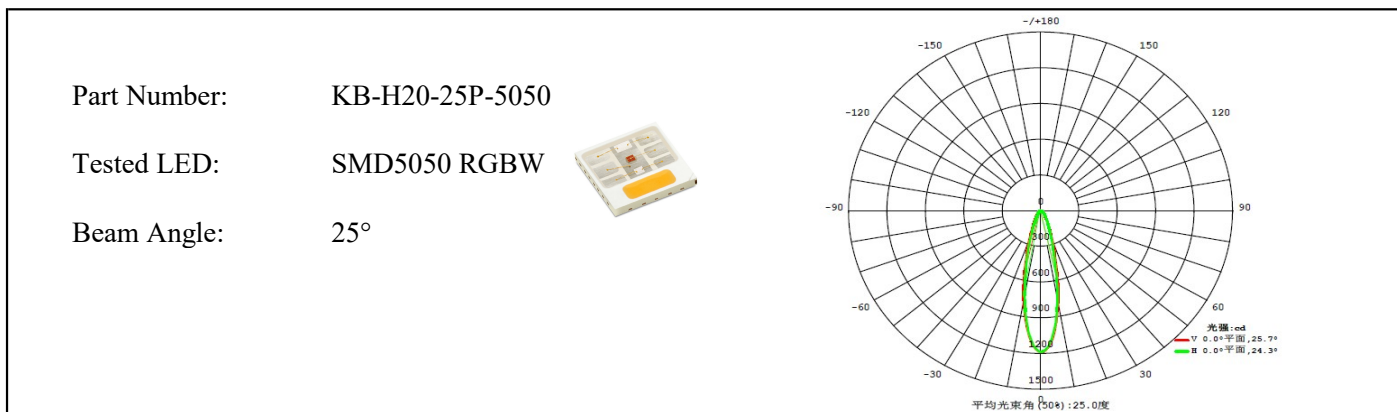

**Light Distribution Curve (配光曲线图):**

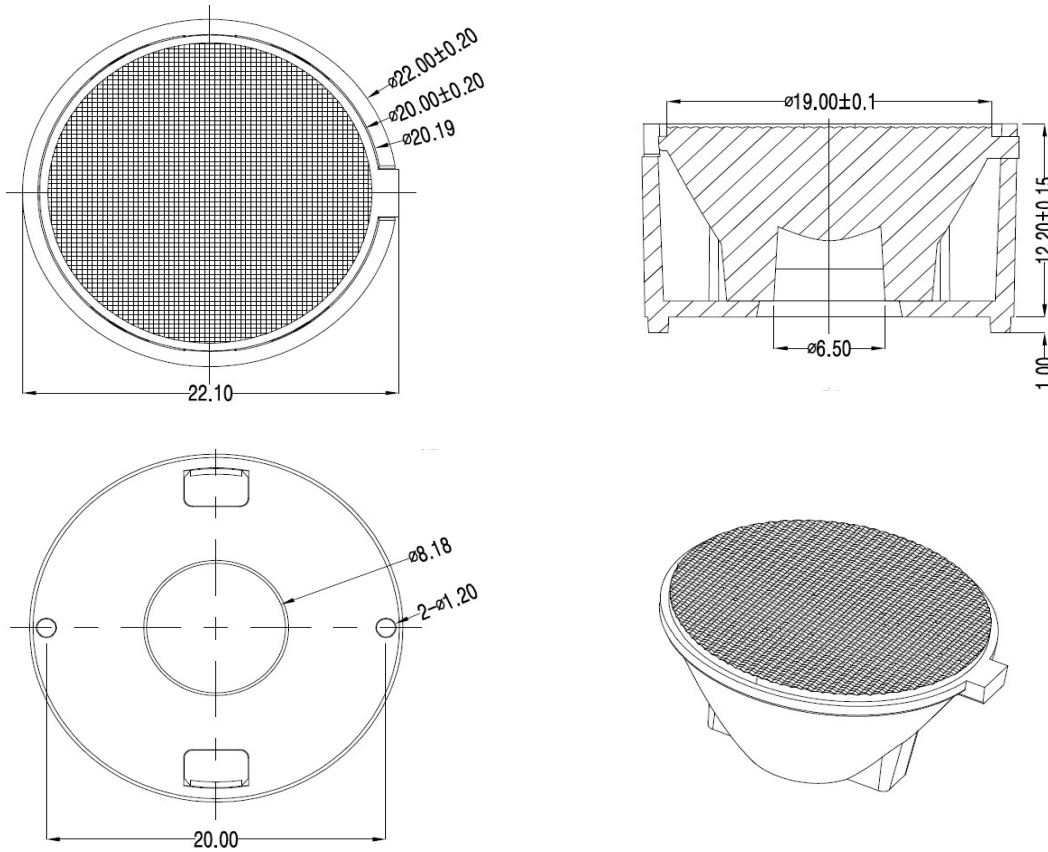

**Mechanical Characteristics (产品尺寸):**



**Product Package (产品包装):**

Inner Box (内盒)	Outer Carton (外箱)
	
<p>25pcs/layer 9layers/box Gross weight: 0.8kg/box Box dimension: 13*13*13cm</p>	<p>20boxes/carton 4,500pcs/carton Gross weight: 17kg/CTN Carton Dimension: 64*28*32cm</p>