

Product Parameters:

- * Product Name: Led Lens
- * Part Number : KB-PL13.5-GH03-180-2835
- * Product Size : $\phi 13.5 * H4.4\text{mm}$

- * Beam Angle : 180 degree
- * Material : PMMA
- * PCB hole-drilling: NO

- * Tolerance: $\pm 0.15\text{mm}$
- * Work Temperature : $-40 \sim 90^{\circ}\text{C}$
- * Transmittance: 93%

- * Application: led panel light (2cm thickness)
- * Assembly : Glue/SMT machine
- * Match Led : SMD2835



* Product Advantages

Large light emitting view angle, uniform light spot, no macula and dark area, high illumination.
Three exhaust holes at the bottom designed for good heat dissipation.

Product Drawing:

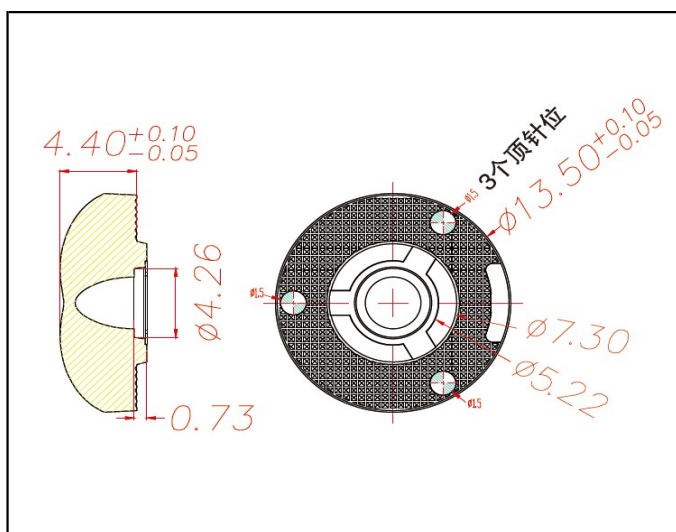

Light Distribution Curve:

