



**Product Parameters (产品描述)**

产品编号 | Part Number: KB-Y23-xx-R-Tape  
 出光角度 | Beam Angle: 6~60°/Oval  
 产品材料 | Material: PMMA+PC  
 工作温度 | Work Temp: <90°C

安装方式 | Fastening: Pins|Glue|Tape  
 支架颜色 | Holder Color: White/Black  
 透光率 | Transmittance: 93%  
 匹配LED | Match Led: 3030/3535/5050 Leds

Part Number	Lens Surface	Dimension	Matched Led	Beam Angle
KB-Y23-6-R-Tape	镜面/clear	Φ23.2*H12.57mm	Cree XPE2/3535	~6°
KB-Y23-8-R-Tape	镜面/clear	Φ23.2*H12.57mm	Cree XPE2/3535	~8°
KB-Y23-10P-R-Tape	珠面/Beads	Φ23.2*H12.57mm	3030/ 3535/ 3535RGBW/ 5050	~10°
KB-Y23-10PM-R-Tape	珠面/Beads	Φ23.2*H12.57mm	3030/ 3535/ 5050	~10°
KB-Y23-12P-R-Tape	珠面/Beads	Φ23.2*H12.57mm	3030/ 3535/ 5050	~12°
KB-Y23-15P-R-Tape	珠面/Beads	Φ23.2*H12.57mm	3030/ 3535/ 5050	~15°
KB-Y23-25P-R-Tape	珠面/Beads	Φ23.2*H12.57mm	3030/ 3535/ 3535RGBW/ 5050	~25°
KB-Y23-25PG-R-Tape	珠面/Beads	Φ23.2*H12.57mm	3030/ 3535/ 3535RGBW/ 5050	Polarized 25°
KB-Y23-45P-R-Tape	珠面/Beads	Φ23.2*H12.57mm	3030/ 3535/ 3535RGBW/ 5050	~45°
KB-Y23-60P-R-Tape	珠面/Beads	Φ23.2*H12.57mm	3030/ 3535/ 3535RGBW/ 5050	~60°
KB-Y23-1020-R-Tape	条纹/Oval	Φ23.2*H12.57mm	3030/ 3535/ 5050	~10*20°
KB-Y23-1040-R-Tape	条纹/Oval	Φ23.2*H12.57mm	3030/ 3535/ 5050	~10*40°
KB-Y23-1550-R-Tape	条纹/Oval	Φ23.2*H12.57mm	3030/ 3535/ 3535RGBW/ 5050	~15*50°

**Light Distribution Curve (配光曲线图):**

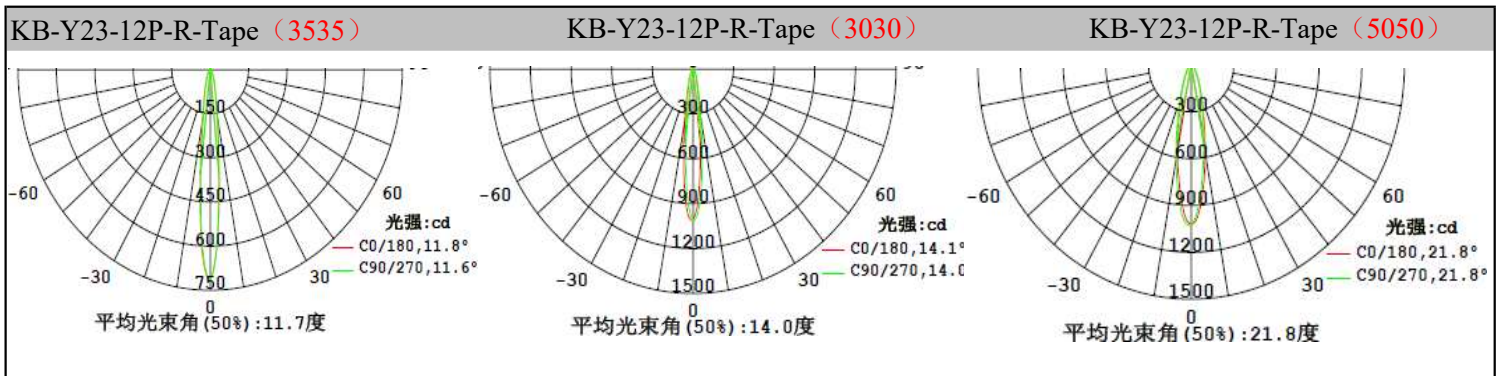
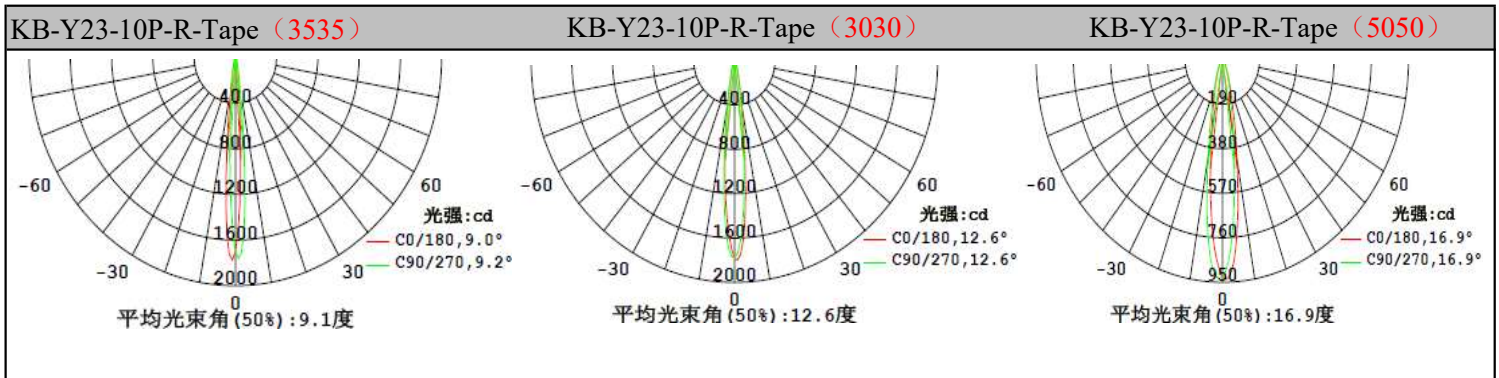
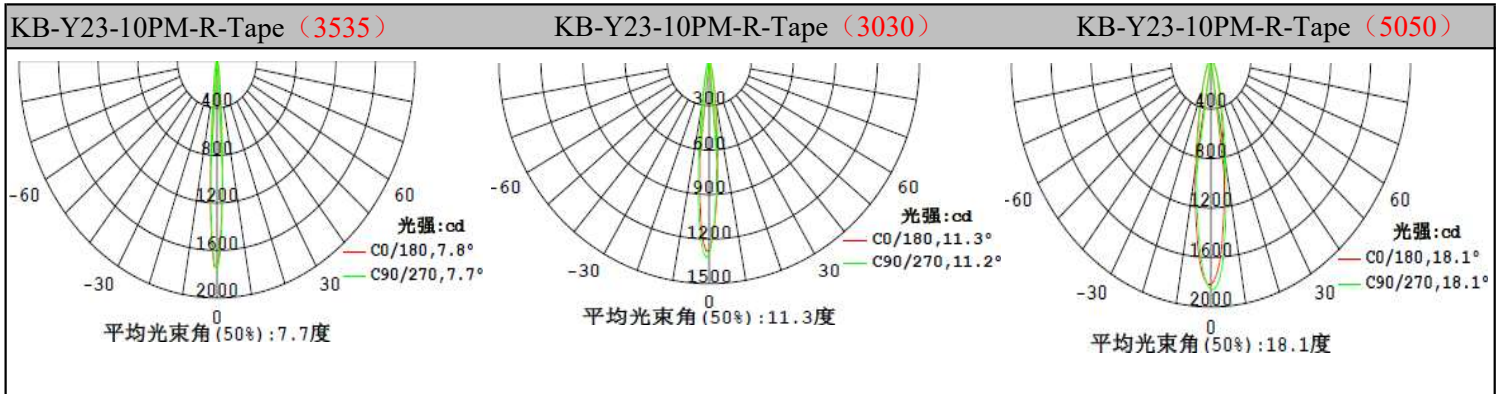
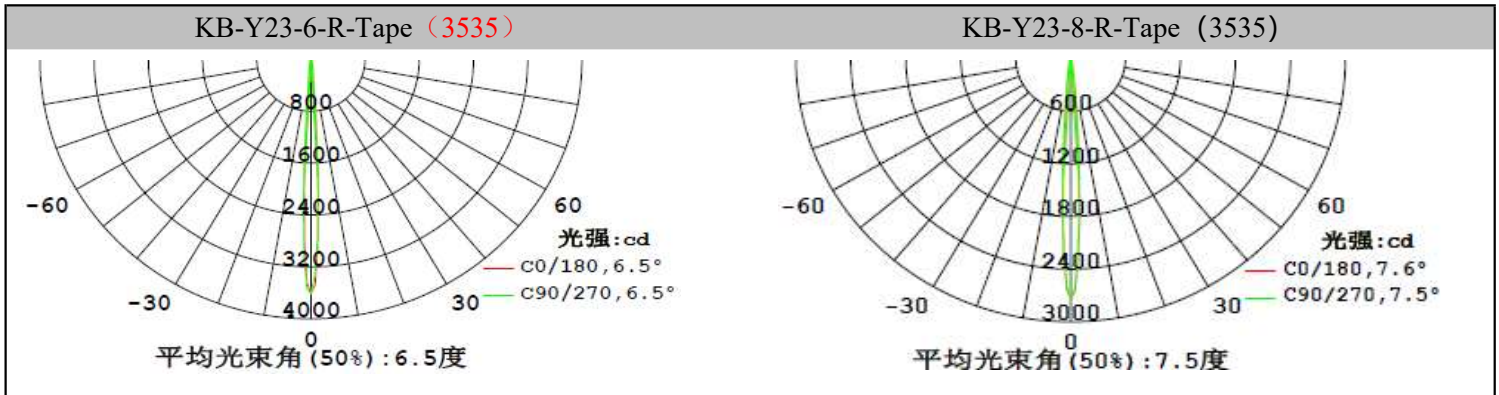



**Light Distribution Curve (配光曲线图):**

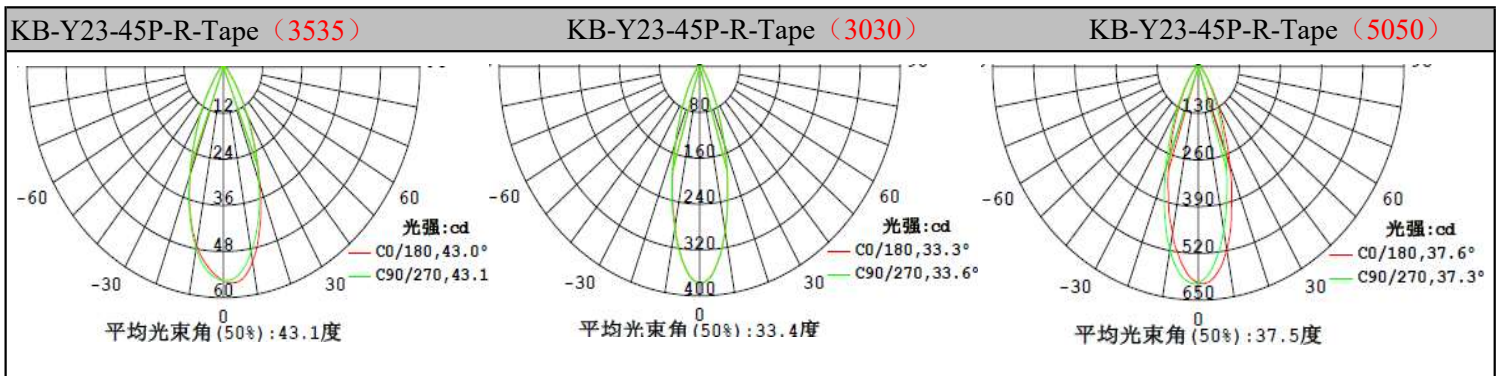
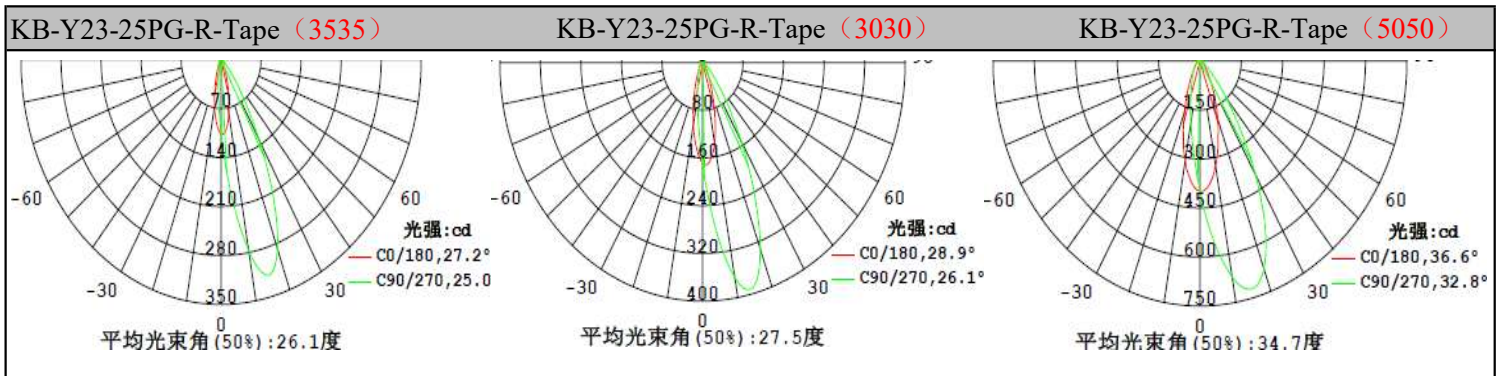
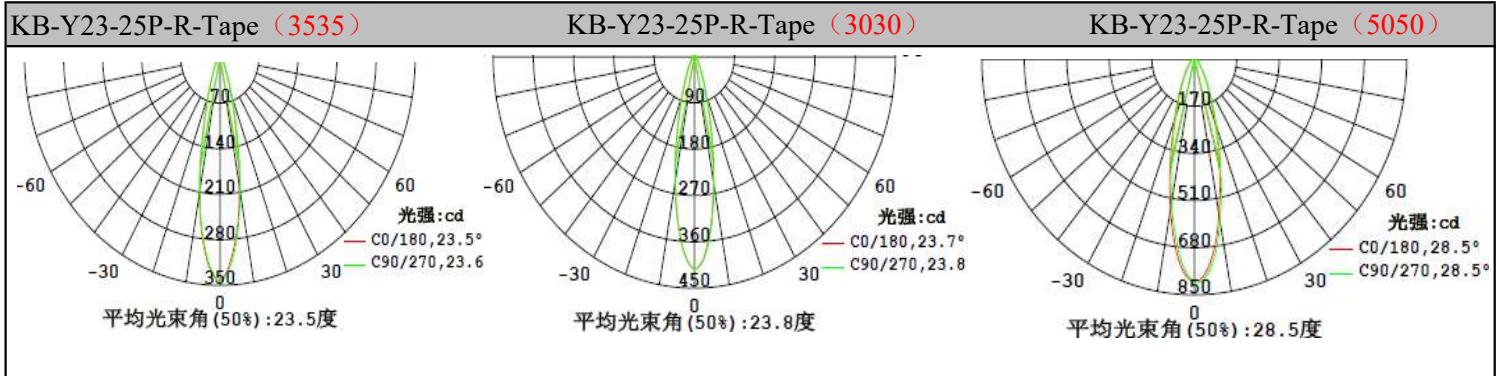
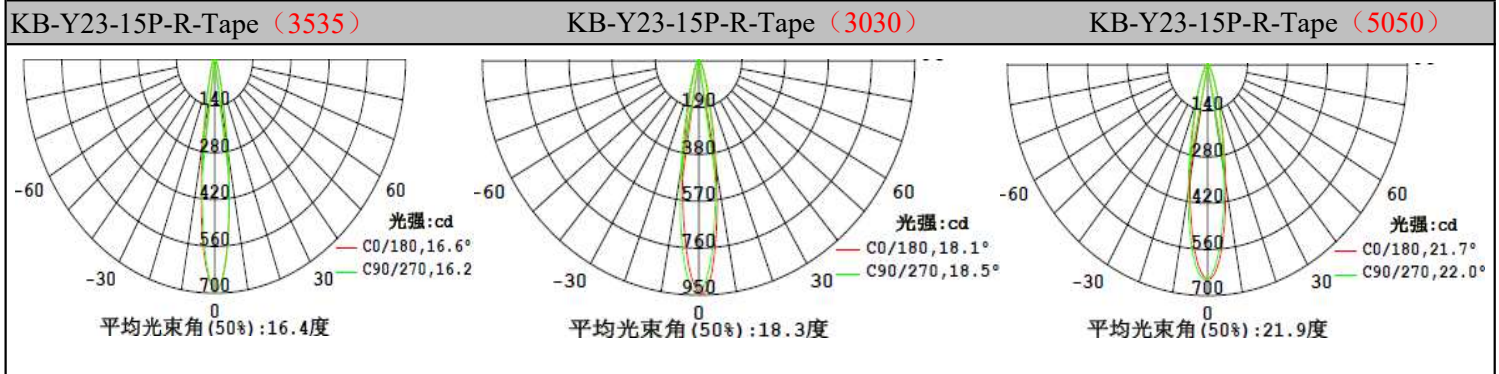



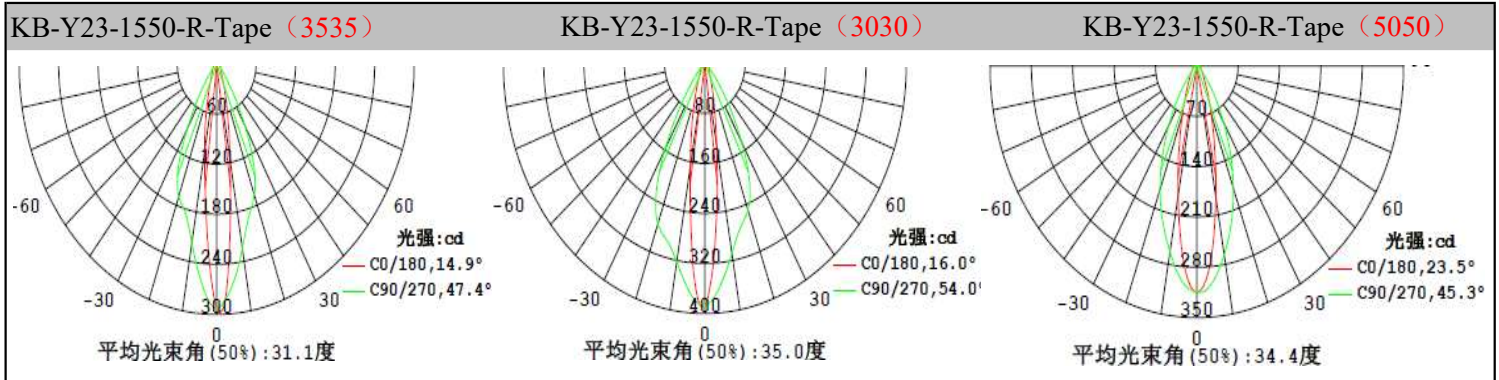
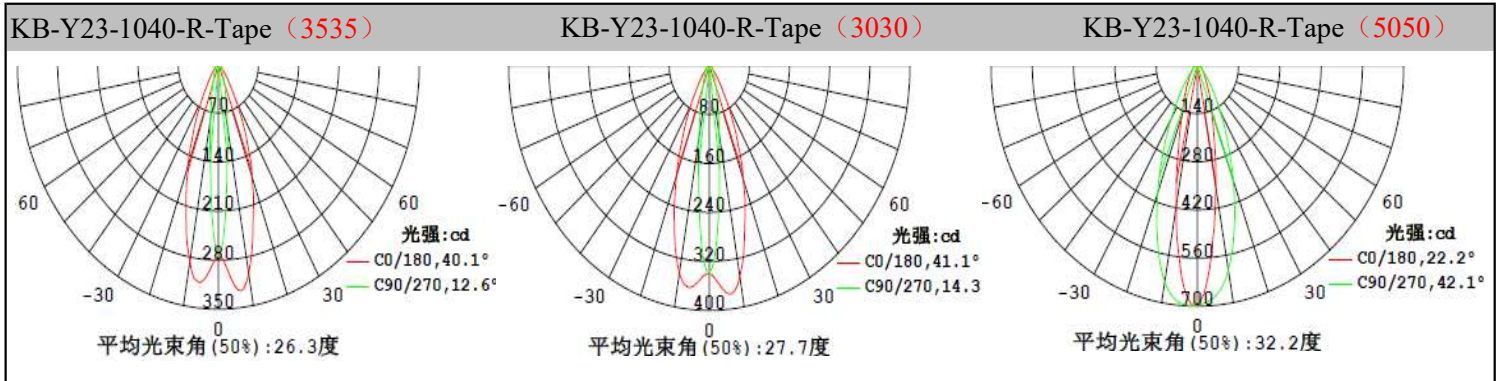
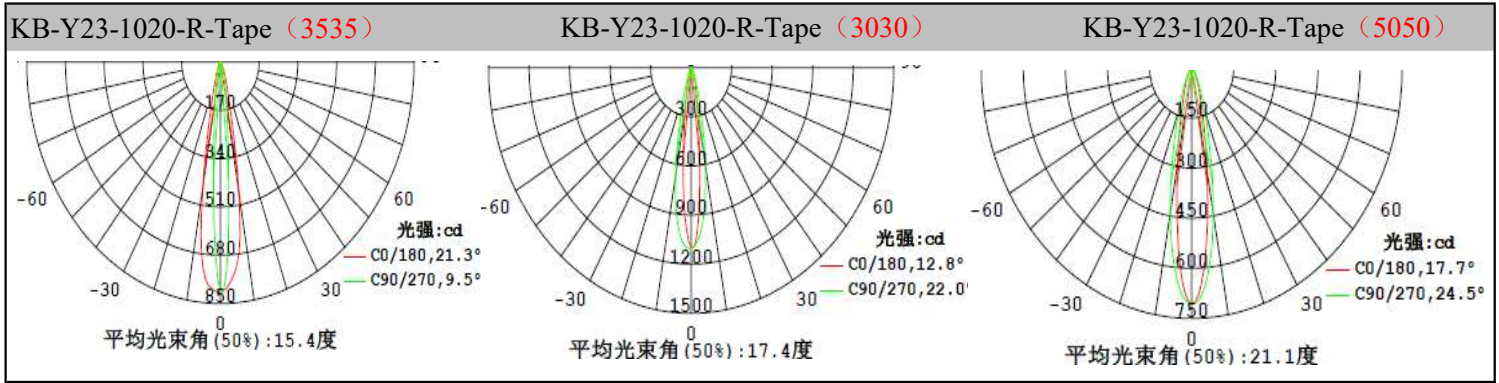
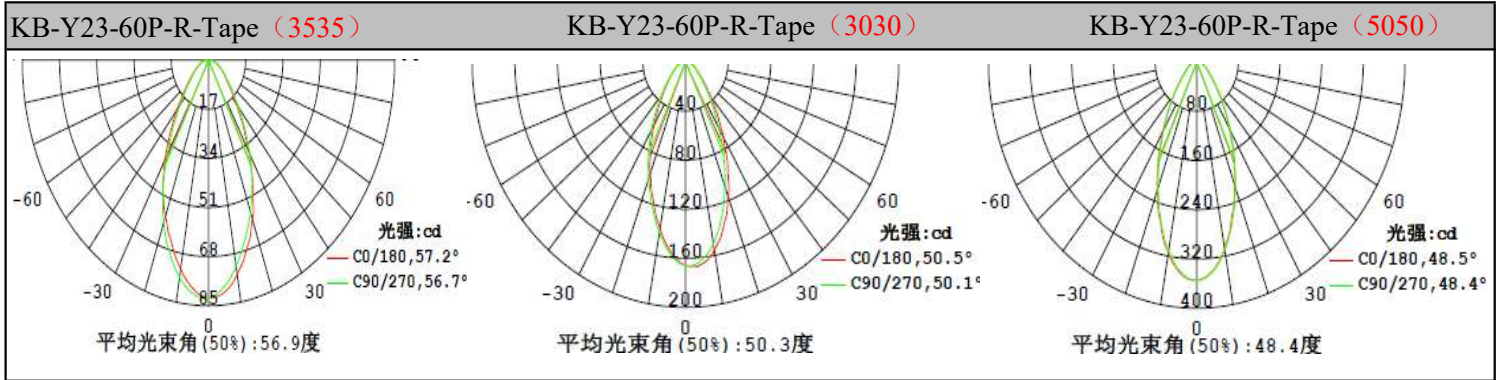

**Light Distribution Curve (配光曲线图):**

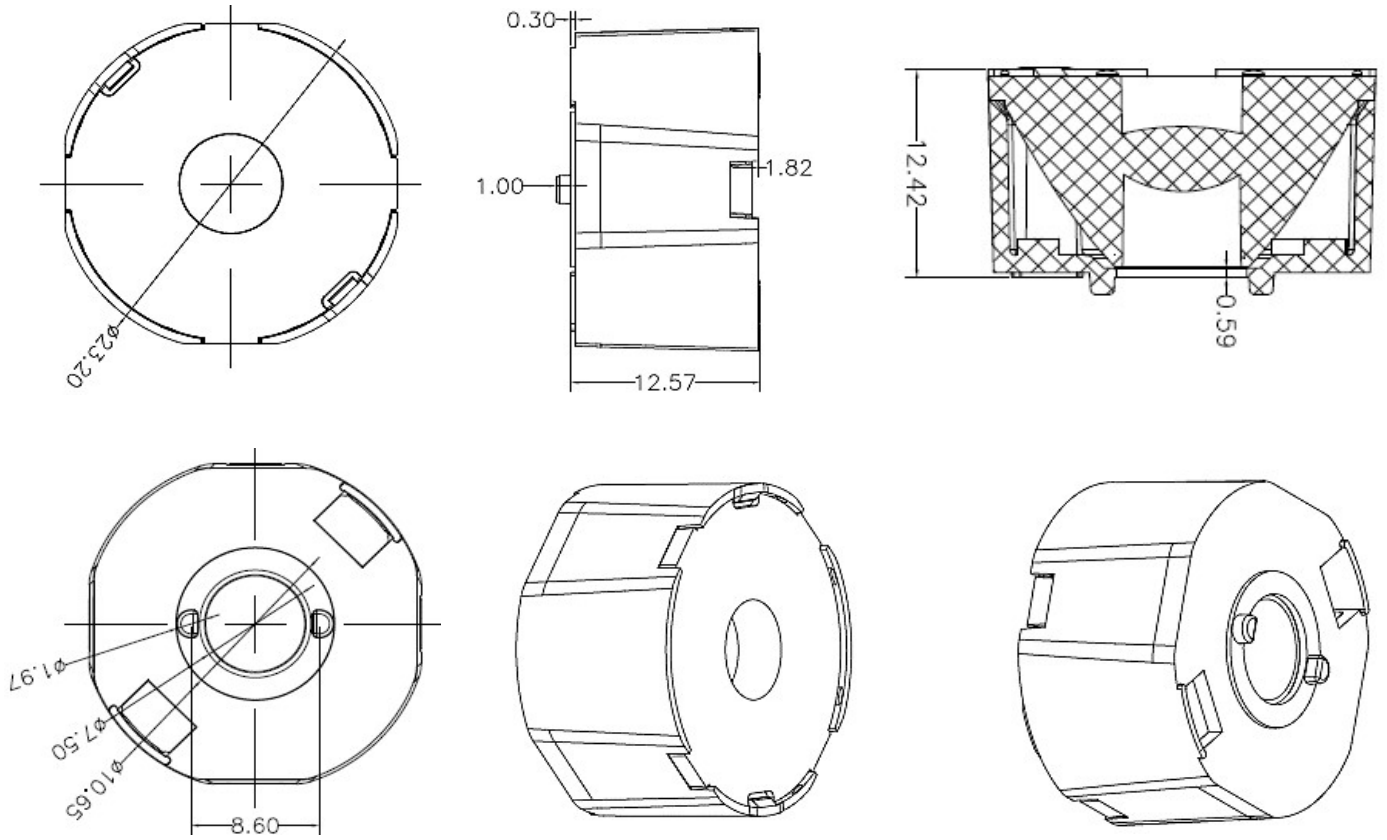

**Mechanical Characteristics (产品尺寸):**



**Product Package (产品包装):**

Inner Box (内盒)	Outer Carton (外箱)
	
<p>25pcs/layer                  225ayers/box                  Gross weight: 0.8kg/box                  Box dimension: 13*13*13cm</p>	<p>20boxes/carton                  4,500pcs/carton                  Gross weight: 17kg/CTN                  Carton Dimension: 64*28*32cm</p>