

Product Parameters:

- * Product Name: Led Lens
- * Part Number : KB-PL13.5-GX03-180-2835
- * Product Size : $\phi 13.5 * H4.88\text{mm}$

- * Beam Angle : 180 degree
- * Material : PMMA
- * PCB hole-drilling: NO

- * Tolerance: $\pm 0.15\text{mm}$
- * Work Temperature : $-40 \sim 90^{\circ}\text{C}$
- * Transmittance: 93%

- * Application: led panel light (3cm thickness)
- * Assembly : Hot-melting
- * Match Led : SMD2835|3030 Leds

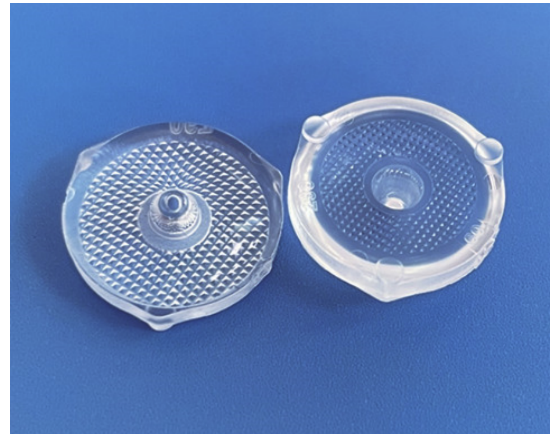

* Product Advantages

Large light emitting view angle, uniform light spot, no macula and dark area, high illumination.
Three locating pins at the bottom, which is good for automatic machining.

Product Drawing:

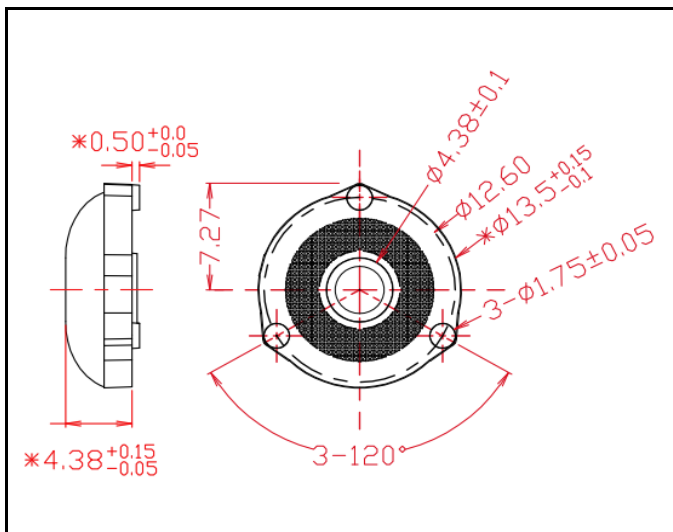

Light Distribution Curve:

