



Product Parameters (产品描述)

产品编号 | Part Number: KB-Y35-xxCOB-ST
出光角度 | Beam Angle: 15/24/36/50°
产品材料 | Material: PC
工作温度 | Work Temp: <105°C

安装方式 | Fastening: Frame
支架颜色 | Holder Color: White only
透光率 | Transmittance: 93%
匹配LED | Match Led: COB Les<6mm

Part Number	Lens Surface	Dimension	Beam Angle
KB-Y35-15COB-ST	磨砂面/Matt	Φ35*H9.5mm	~15°
KB-Y35-24COB-ST	磨砂面/Matt	Φ35*H9.5mm	~24°
KB-Y354-36COB-ST	磨砂面/Matt	Φ35*H9.5mm	~36°
KB-Y35-50COB-ST	磨砂面/Matt	Φ35*H9.5mm	~50°

Direction for Use (使用须知)

- 1, Please use some soft paper or pure water to clean lens (reflector)
- 2, Don't use any industrial solvent to clean lens surface , such as alcohol
- 3, Storage environment : Temperature 0~40°C , Humidity 30%~95%
- 4, This kind of lens can make the lighting more concentrated, and it's made from transparent material , so please do not open the packages until you use them, in case of the dust and other pollutions.

Light Distribution Curve (配光曲线图)

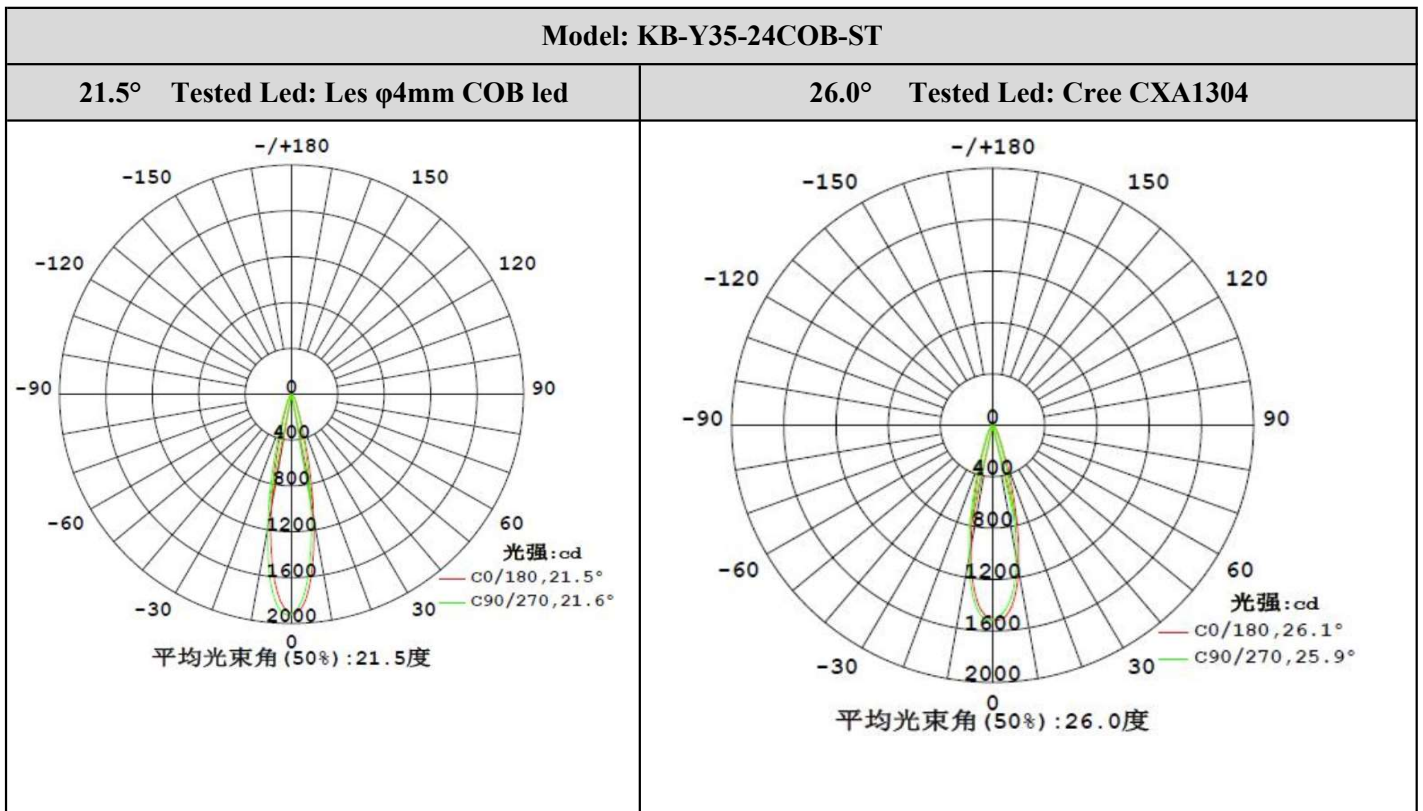
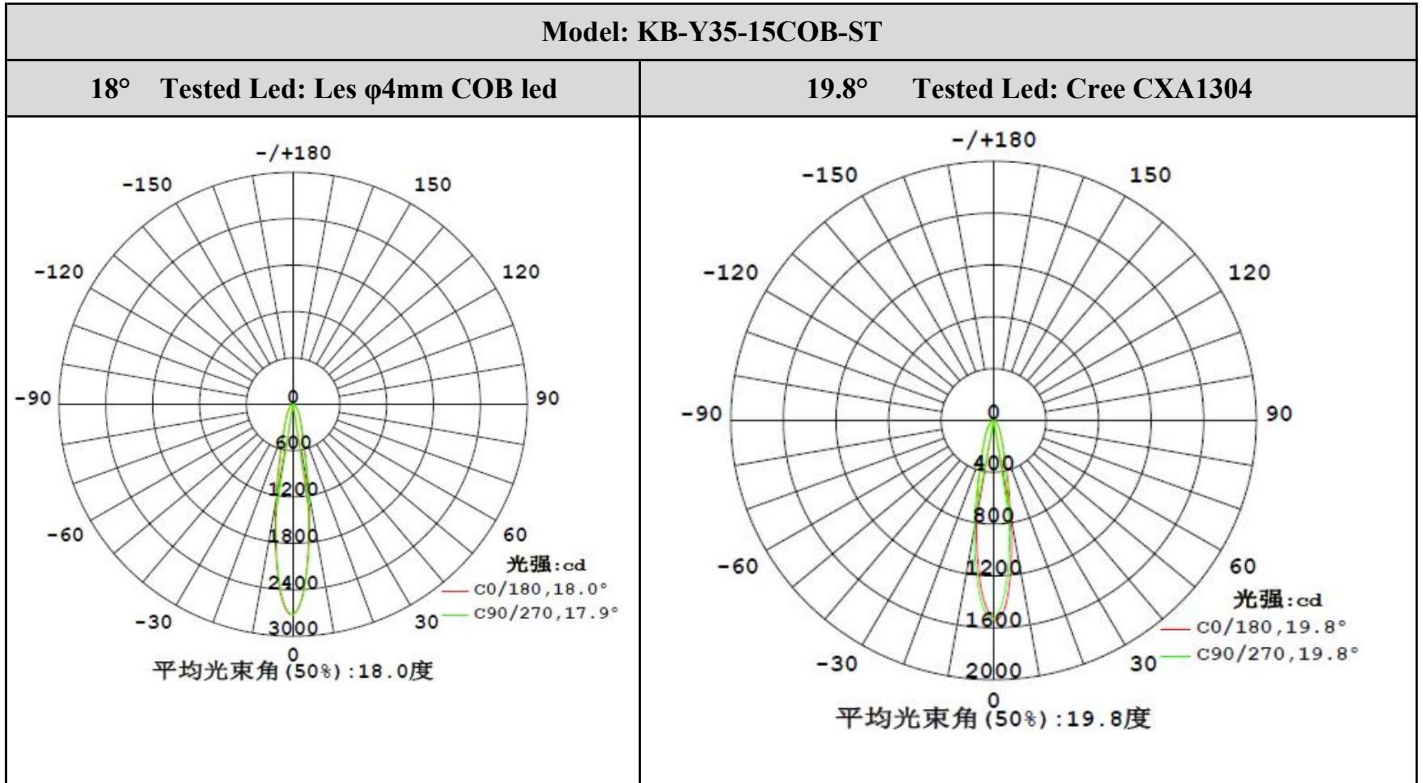

Light Distribution Curve (配光曲线图)

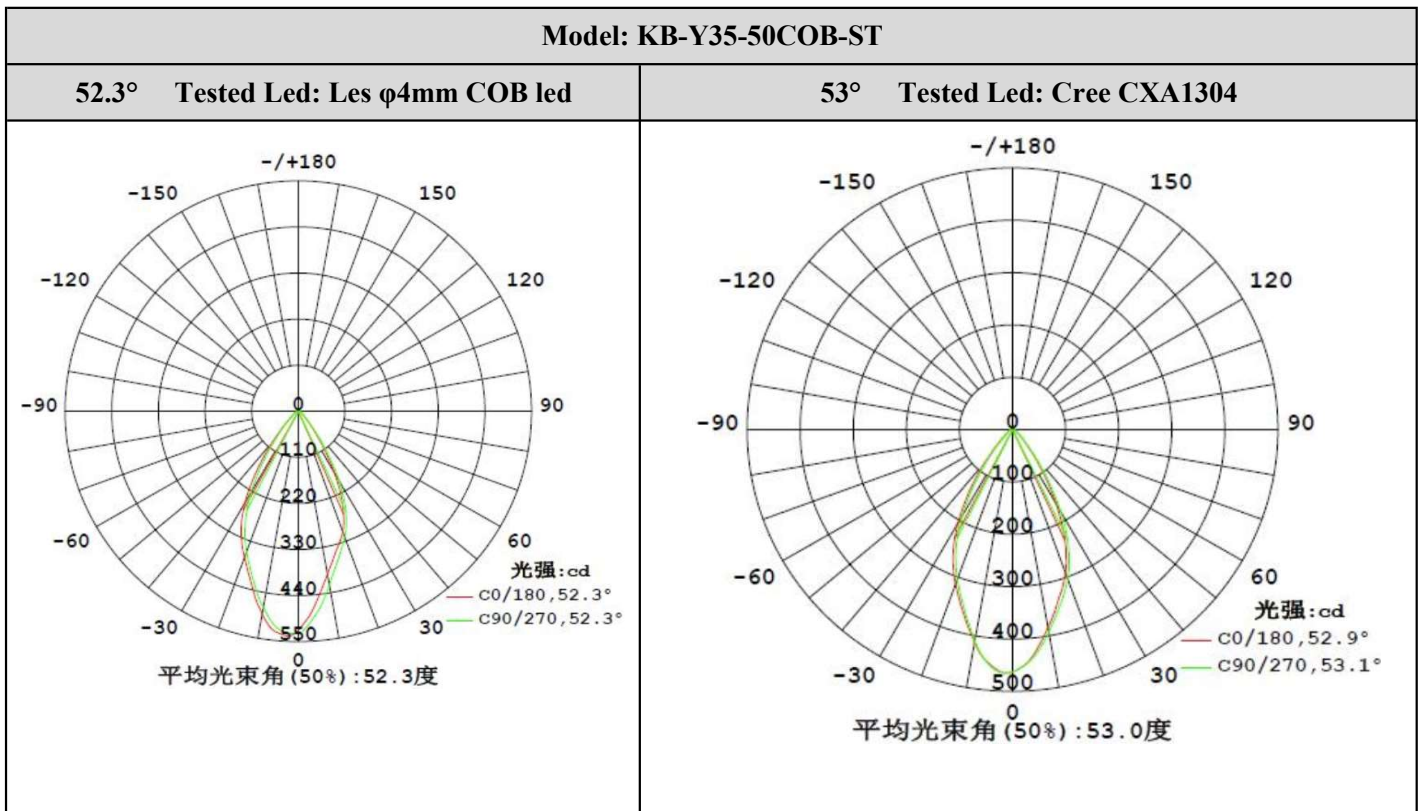
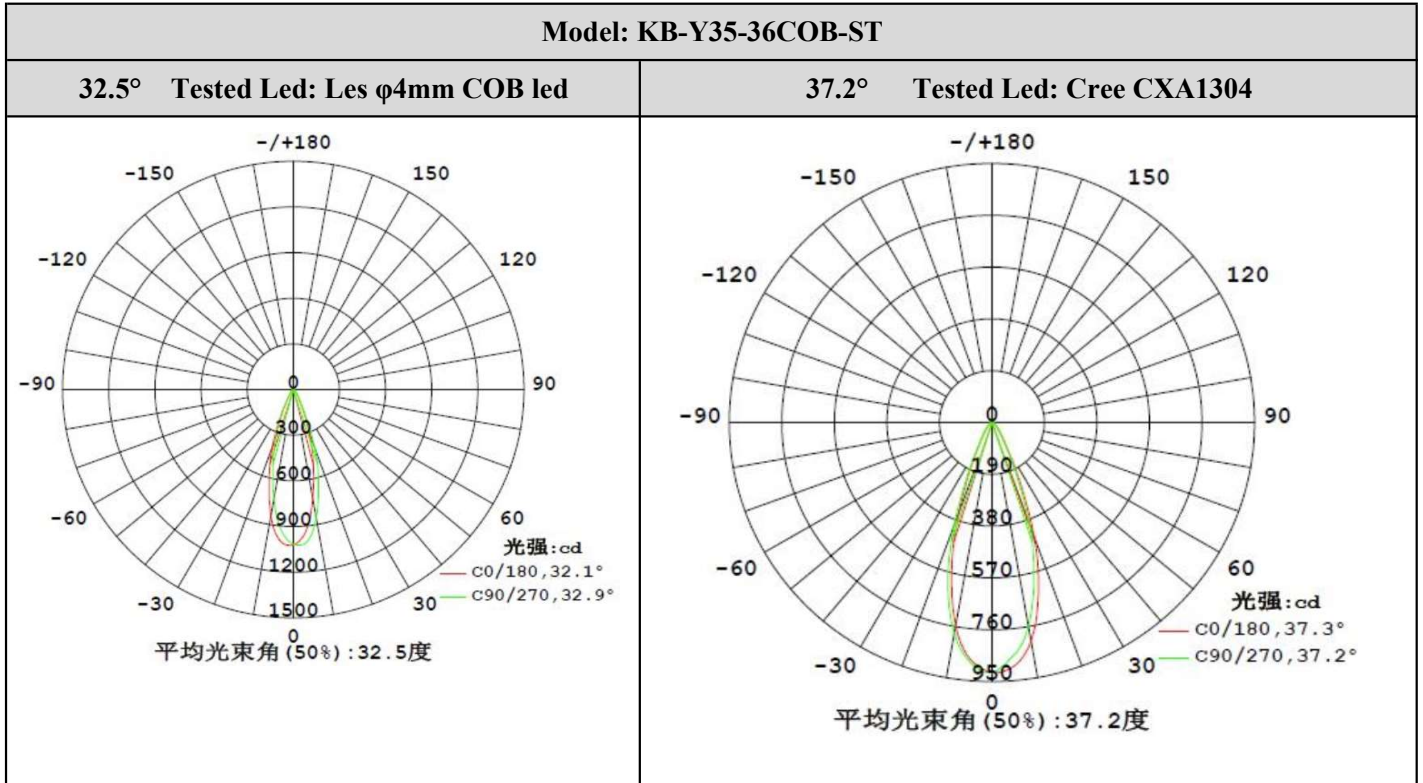

Mechanical Characteristics:

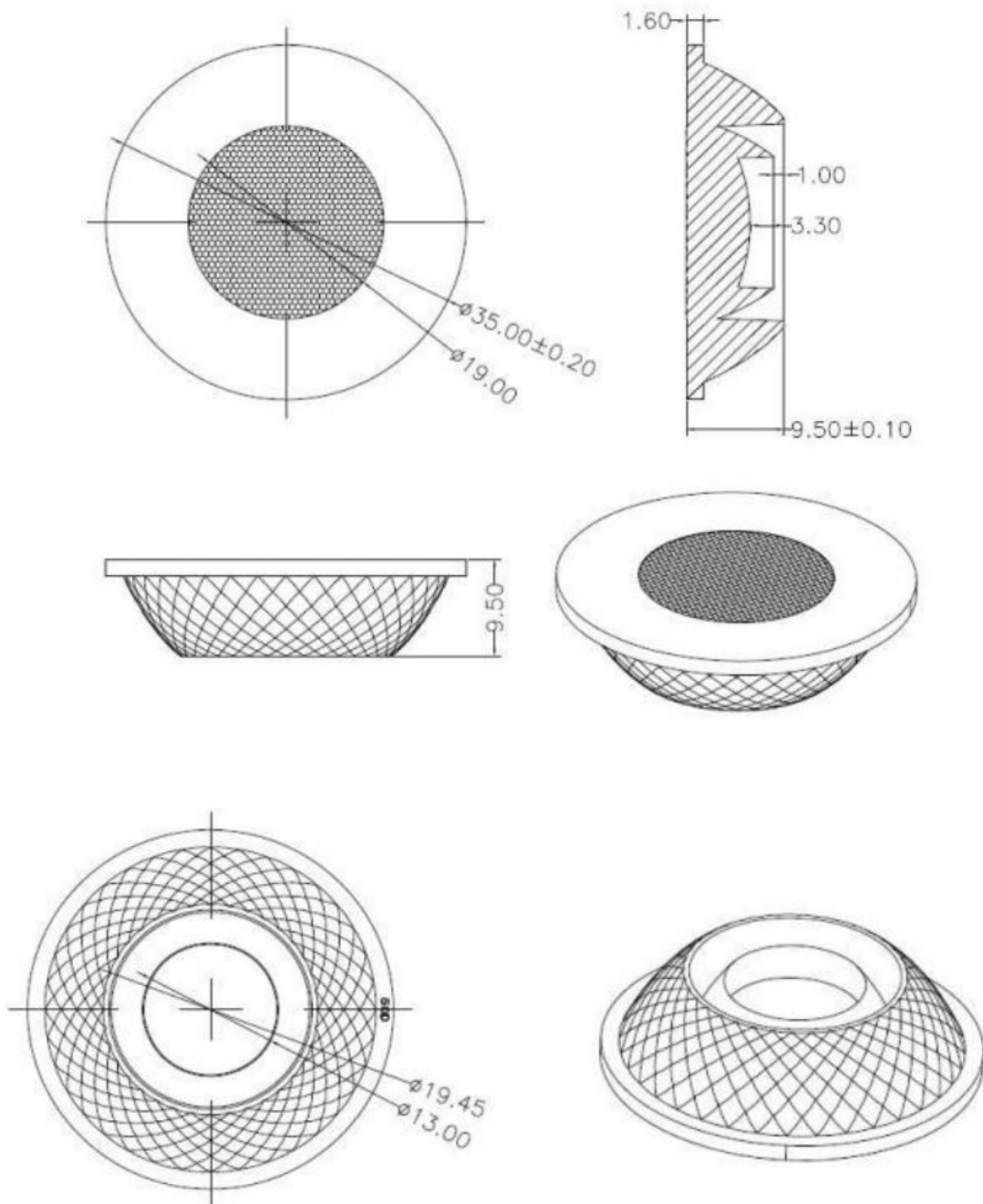

Mechanical Characteristics:

